

## **Design and Development of an Automated Multi Axis Solar Tracker Using PLC**

**Santhosh K V<sup>\*1</sup>, J S Rajshekar<sup>2</sup>**

<sup>1</sup>Department of Electrical Engineering, National Institute of Technology, Silchar, India

<sup>2</sup>Department of Instrumentation Technology, Dayanandasagar College of Engineering, Bangalore, India

\*Corresponding author, e-mail: kv.santhu@gmail.com<sup>1</sup>, j.rajshekar@gmail.com<sup>2</sup>

### **Abstract**

*Design of a two dimensional automated solar tracking system is discussed in this paper. The objectives of the proposed work are to design an automated tracking technique using Light Dependent Resistance (LDR), and solar panel power output to position the solar panel to absorb maximum energy. For positioning the solar panel two stepper motors are used, each for positioning in a plane. These stepper motors were driven by a Programmable Logic Controller (PLC). The controller is designed using wonderware software considering the inputs from LDR Sensor and solar panel output to drive the stepper motor connected to solar panels. Then the whole program is implemented with the help of PLC. The system was tested on a real time and results showed the proposed technique had improved the efficiency of solar panel by an amount of 25%.*

**Keywords:** automation, LDR, PLC, solar tracking, solar energy.

### **1. Introduction**

Electricity is fundamental to the quality of our lives. Nowadays, we are totally dependent on an abundant and uninterrupted supply of electricity for living and working. It is a key ingredient in all sectors of modern economies. We use it constantly at home and at work. Electricity maintains our standard of living and economy. From the time you wake up to the time you go to sleep. Electricity is important in everyone's life, whether you notice it or not. Now a day's energy has become more important for the collective good than individual's need. Electricity runs like blood through the veins of economy without it the economy will tremble and it will be difficult for it to survive. Taking in account the diminishing natural resource known to mankind is the need of the hour, that someone stood up and discover new horizons explore more possibilities and bring forward new ideas to fulfill the exponentially increasing energy needs of the world's population [1-6].

Electricity is most often generated at a power station by electromechanical generators, primarily driven by heat engines fueled by chemical combustion or nuclear fission (non-renewable energy) but also by other means such as the kinetic energy of flowing water and wind. There are many other technologies that can be and are used to generate electricity such as solar photovoltaics and geothermal power (renewable energy) [7-11].

Non-renewable energy is energy, taken from "finite resources that will eventually dwindle, becoming too expensive or too environmentally damaging to retrieve", as opposed to renewable energy sources. Renewable energy is energy generated from natural resources-such as sunlight, wind, rain, tides, and geothermal heat-which are renewable (naturally replenished). In 2006, about 18% of global final energy consumption came from renewable; the majority of renewable energy technologies are powered by the sun. Solar energy is the radiant light and heat from the Sun that has been exploited by humans since ancient times using a range of ever-evolving technologies. The Earth receives 174 pet watts (PW) of incoming solar radiation at the upper atmosphere. Approximately 30% is reflected back to space while the rest is absorbed by clouds, oceans and land masses. The spectrum of solar light at the Earth's surface is mostly spread across the visible and near-infrared ranges with a small part in the near-ultraviolet [12-16].

A solar cell or photovoltaic cell is a device that converts light directly into electricity by the photovoltaic effect. Sometimes the term solar cell is reserved for devices intended specifically to capture energy from sunlight, while the term photovoltaic cell is used when the light source is unspecified. Assemblies of cells are used to make solar panels, solar modules, or photovoltaic arrays. Most photovoltaic (PV) solar panels are fitted in a fixed location- for example on the sloping roof of a house, or on framework fixed to the ground. Since the sun moves across the sky though the day, this is far from an ideal solution. Solar panels are usually set up to be in full direct sunshine at the middle of the day facing South in the Northern Hemisphere, or North in the Southern Hemisphere. Therefore morning and evening sunlight hits the panels at an acute angle reducing the total amount of electricity which can be generated each day [4], [7], [12].

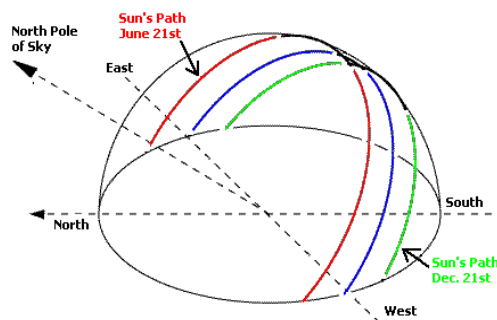

Figure 1. Sun's Apparent Motion

During the day the sun appears to move across the sky from left to right and up and down above the horizon from sunrise to noon to sunset. Figure 1 shows the schematic above of the Sun's apparent motion as seen from the Northern Hemisphere. To keep up with other green energies, the solar cell market has to be as efficient as possible in order not to lose market shares on the global energy marketplace. There are two main ways to make the solar cells more efficient, one is to develop the solar cell material and make the panels even more efficient and another way is to optimize the output by installing the solar panels on a tracking base that follows the sun.

A lot of research is carried on in this field, literature survey suggests. In [1], design of automatic solar tracking device is discussed using real time clock in single dimension. In [2], two axis solar tracking system is discussed using the real time clock. In [3], microcontroller based design methodology of an automatic solar tracker is presented. In [4], microcontroller based two-axis solar tracking is designed and developed using LDR sensor and dc motor on a mechanical structure with gear arrangement. In [5], single axis solar tracking mechanism is being discussed using real time clock. In [6], they propose a detector for one or two axis automatic orientation, which permit a continuous tracking for entire zenith angle range. In [7], ripple correlation control method is presented and verified against experiment. In [8], automatic solar tracking system based on one-chip computer is discussed. Here the tracking is based on the real time clock.

The paper is organised as follows: after introduction in Section-1, a brief description on each component of block diagram is given in Section-2. Section-3 deals with the problem statement followed by proposed solution in Section-4. Finally, result and conclusion is given in Section-5.

## 2. Block Diagram

The block diagram of the proposed technique is as given in Figure 2, followed by the description.

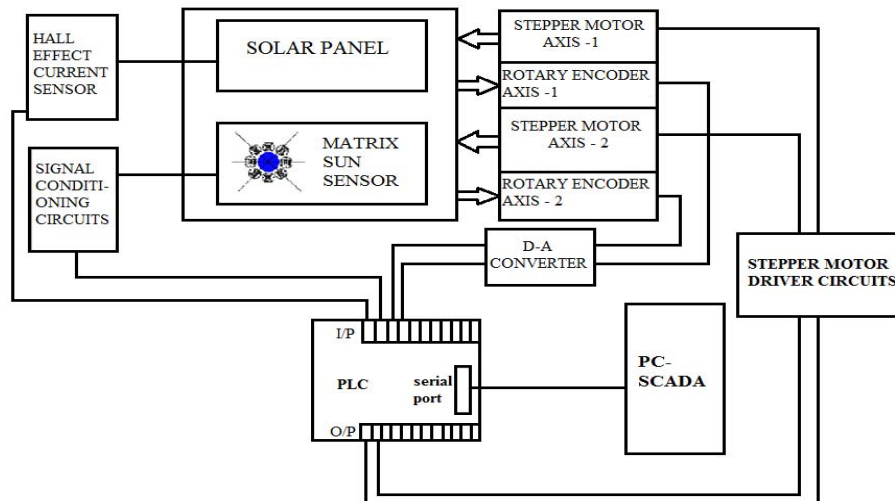

Figure 2. Block Diagram of the Proposed Technique

**2.1. LDR (Matrix Sun Sensor)**

LDR is made of a high-resistance semiconductor [9]. It can also be referred to as a photo resistor. If light falling on the device is of the high enough frequency, photons absorbed by the semiconductor give bound electrons enough energy to jump into the conduction band. The resulting free electron (and its hole partner) conduct electricity, thereby lowering resistance. Hence, LDR is very useful in light sensor circuits.

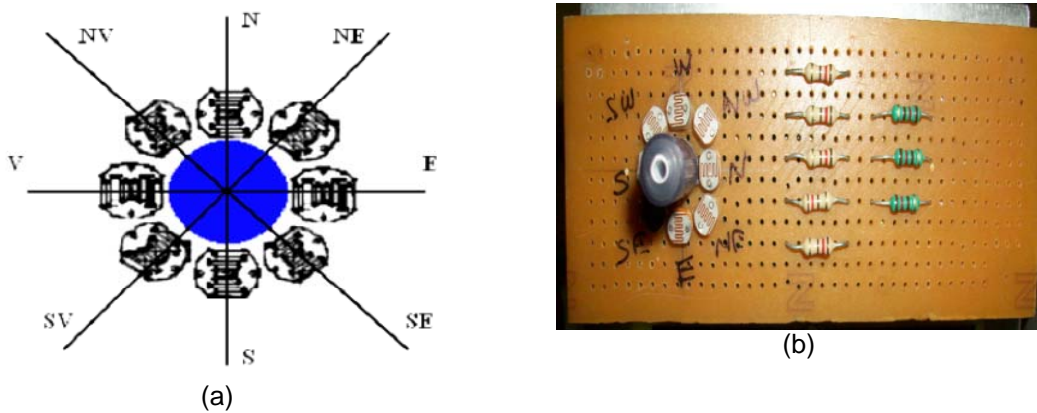

Figure 3. (a) Pictorial representation of MSS, (b) Actual photograph of MSS

The topology and working principle of the proposed Matrix Sun Sensor (MSS) respect the antique solar clock. Each LDR cell corresponds to a direction: N, NE, E, SE, S, SW, W and NW (see Figure 3).

The MSS logic operation is:

- a. If the N LDR cell is shaded, the N-S actuator moves in the opposite direction, southward.
- b. If the N-E LDR cell is shaded, both actuators must move in the opposite direction: N-S actuator moves southward and EV actuator moves westward.
- c. If the E LDR cell is shaded, the E-V actuator moves in the opposite direction, westward.
- d. If the S-E LDR cell is shaded, both actuators must move in the opposite direction: N-S actuator moves northward and EV actuator moves westward.
- e. If the S LDR cell is shaded, the N-S actuator moves in the opposite direction, northward.

- f. If S-W LDR cell is shaded, both actuators must move in the opposite direction: N-S actuator moves northward and E-V actuator moves eastward
- g. If the W LDR cell is shaded, the E-V actuator moves in the opposite direction, eastward.
- h. If the N-W LDR cell is shaded, both actuators must move in the opposite direction: N-S actuator moves southward and EV actuator moves eastward.

## 2.2. Solar Panel

A solar panel is a collection of solar cells. Although each solar cell provides a relatively small amount of power, many solar cells spread over a large area can provide enough power to be useful. To get the most power, solar panels have to be pointed directly at the Sun [10, 11].

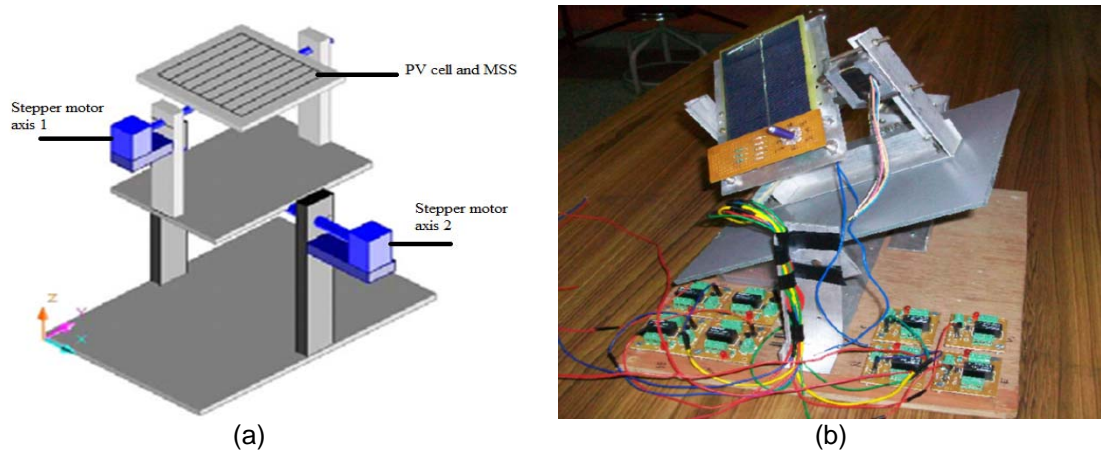

Figure 4. (a) Pictorial representation of solar plate mounting, (b) actual photograph of sensor array used.

## 2.3. Hall Effect Current Sensor

The Hall effect is the production of a voltage difference (the Hall voltage) across an electrical conductor, transverse to an electric current in the conductor and a magnetic field perpendicular to the current. This principle is used for measuring current from a photovoltaic cell. The system uses the WCS2702 Hall Effect Base Linear Current Sensor [12].

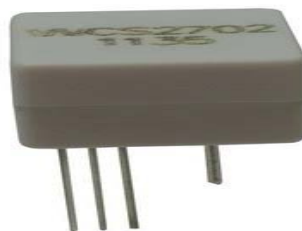

Figure 5. Hall Effect Sensor

## 2.4. PLC (HC900)

The HC900 Hybrid Controller is an advanced process and logic controller with a modular, scalable design that is built to work with a wide range of process equipment in a cost-effective way. This logic controller comes with a touch screen operator interface which makes it very easy to operate. The hybrid controller possesses a flexible architecture that can accommodate the most demanding application, and with its advanced features and versatile connectivity, is capable of customized pinpoint control. The HC900 hybrid controller also simplifies the documentation process and eliminates filing errors.

### 3. Problem Statement

Here, we are proposing an experimental setup for automatic solar tracking system. At first, by the help of LDR MSS structure which is designed we can sense the direction of sun, to measure the output of solar panel a hall-effect sensor is used. Then the signal acquired is processed with the help of ladder logic diagram written on a PLC. Design a controller using a programmable logic controller, to drive two stepper motors. Two stepper motors are used to control the movement of solar panel in two dimensions.

### 4. Problem Solution

To achieve the tasks proposed in the earlier section a technique is proposed with the help of sensor system, PLC, and PC. The block diagram of the same is as shown in the Figure 6. It has the following main parts:

1. **TRACKING MODULE:** Tracking module consists of LDR sensor array, hall-effect sensor.
2. **INTERFACING MODULE:** It converts the output signal of the sensor array into voltage signal so as to make the system output compatible with the controller's input.
3. **CONTROLLER:** The analog signal from process is converted into digital form and then transferred serially to the system (PC) by controller.
4. **SYSTEM (PC):** The acquired data from the process is stored in PC and used for further processing.

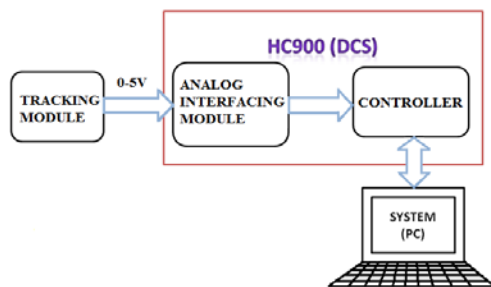

Figure 6. Interconnection Model of Proposed Technique

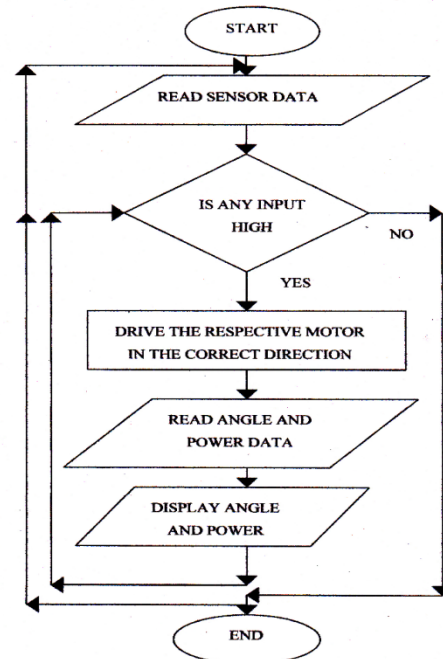

Figure 7. Flow Chart of Program in PLC

This program controls the solar tracker movement in both axes by acquiring the sensor data and controlling the motors through the written algorithm, it also acquires the angle of both axis and also reads the power output of the solar panel [13-15].

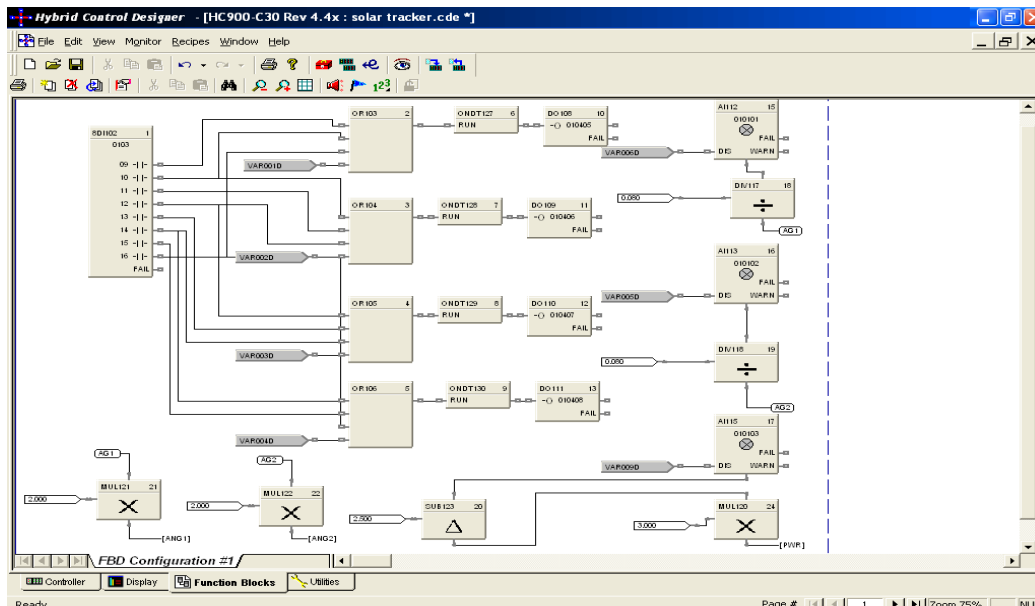

Figure 8. Program Written on DCS

The functioning of the program is as follows:

- The data from the sensor is read through an 8 point digital input module; the eight inputs are the signals from the LDRs in N, NE, E, SE, S, SW, W and NW directions.
- Output of the digital input module is given to the 3 inputs of the 4 input OR gate in such way that the inputs containing the north component are connected to one OR gate and so on is repeated for all other direction components.
- The output of the OR gate is connected to the digital output module through an on time delay of 0.1s. The output controls the rotation of the motor in one direction. There are two motors and hence we get 4 direction of rotation to which 4 digital outputs are connected.
- The angle of rotation in both direction measured using encoder is read through a analog input module and output is divided by the resolution of DAC which is 80mv and multiplied by 2 since each bit of DAC detects 2 degree of rotation and hence it gives the angle as output.
- The current of the solar panel is measured through a hall effect sensor and is given to a analog input module, the output of the analog input is subtracted by 2.5 to remove the offset and later multiplied by 3 which is the panel voltage to get the power.

To develop the Data Acquisition system in Wonderware InTouch first the addresses of signal tag in the hybrid control designer should be exported to a excel file by using the export report option in the file menu and selecting FBD option and in that all Modbus register option must be selected and then save the excel file and note down all the signal tag addresses. Next step is to configure the Modbus by selecting the appropriate com ports.

After the initial configurations open Wonderware InTouch application and create a new application by giving desired directory and names. Open the newly created application and follow the following steps:

- Create a new window by clicking new window option in the file menu and give a name for it.
- In the new window click special and select access name a window will appear in that click add and it give a name and in application tab give name as MODBUS and click ok the access name will be created In the new window select the text tool and write "##" and double click on it to configure it.
- To configure the tag select the type of signal as analog and click next link and in the window appeared give the tag name and double click on the tag name to configure define the tag by selecting type as I/O real and giving the address got in the excel file in the item tab and also give a access name which has been created before.
- Create as many tags as required in the same way.
- Click Runtime to view the output.

Three important parameters are displayed on the Wonderware InTouch view:

- Orientation of axis 1 in degrees.
- Orientation of axis 2 in degrees.
- Total Electrical Power generated by the solar panel in watts.

The Data Acquisition System developed using Wonderware InTouch [16] is shown in Figure 9.

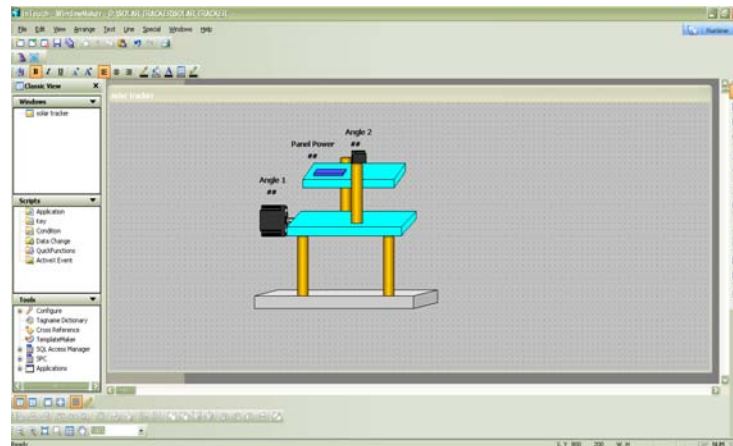

Figure 9. Solar Tracker Model as on Wonderware

## 5. Results and Conclusion

The project focuses on the optimization of the electric energy production by photovoltaic cells through the development of an intelligent sun tracking system with a PLC based control with two different DOF (Degrees Of Freedom). The implemented strategy has many advantages over conventional tracking systems available in the market. This system is autonomous regarding the information needed to process the optimal orientation. The main advantage of the system is due to the use of PLC for control. With PLC as controller it is possible to control large number PV cells and expansion becomes much easier because of the modular nature of the PLC. Thus it is economical for large scale implementations. PLC's are highly customizable and debugging is much easier compared to microcontrollers. The modular natures of PLCs allow expansion and hard wiring of the PLCs make them suitable for use in harsh conditions. Remote measurement of the power generated is achievable through Data Acquisition System (DAQ) and the system can be further upgraded with respect to network capabilities. The data acquired through DAQ can be made available through the internet or the GSM mobile network for easier monitoring of the entire system.

Then entire system was subjected to test for a span of 15 days (Region: Bangalore, India, 12.9833° N, 77.5833° E), the data was collected once in every one hour from morning 8:00 to 5:00 in the evening. The data thus obtained for 15 days are averaged hour wise and is tabulated in the Table 1.

Table 1. Results Obtained from the Proposed Technique

| Time     | O/p of solar panel in fixed mode in Volts | O/p of solar panel in tracking mode in Volts | % improvement |
|----------|---|--|---------------|
| 8:00 AM  | 7.83                                      | 7.91   | 1.01          |
| 9:00 AM  | 8.11                                      | 8.13   | 0.25          |
| 10:00 AM | 8.53                                      | 8.529  | -0.01         |
| 11:00 AM | 9.37                                      | 9.358  | -0.13         |
| 12:00 PM | 10.89                                     | 10.88  | -0.09         |
| 1:00 PM  | 9.77                                      | 10.77  | 9.29          |
| 2:00 PM  | 8.12                                      | 10.73  | 24.32         |
| 3:00 PM  | 6.18                                      | 9.78   | 36.81         |
| 4:00 PM  | 5.12                                      | 8.67   | 40.95         |
| 5:00 PM  | 4.07                                      | 7.99   | 49.06         |

From the table it is evident that the proposed technique has improved the efficiency of the solar panel when compared to fixed mode. The root mean square efficiency was found to be 24.73% improved as compared to existing technique.

## References

- [1] Feng-run Liu, Le Xiao, Wen-jia Li. *The design of automatic solar tracking system for solar cell*. IEEE 2nd International Conference on Artificial Intelligence, Management Science and Electronic Commerce (AIMSEC). 2011; 4451–4454.
- [2] Huifeng Jiao, Jianzhong Fu, Yuchun Li, Jintao Lai. Design of automatic two-axis sun-tracking system. IEEE International Conference on Mechanic Automation and Control Engineering (MACE). 2010; 2323–2326.
- [3] Khan MTA, Tanzil SMS, Rahman R, Alam SMS. *Design and construction of an automatic solar tracking system*. IEEE 6th International Conference on Electrical and Computer Engineering (ICECE). 2010; 326–329.
- [4] Bajpai P, kumar S. *Design, development and performance test of an automatic two-axis solar tracker system*. Annual IEEE Conference Publication, India Conference (INDCON) 2011; 1–6.
- [5] Ponniran A, Hashim A, Munir HA. *A design of single axis sun tracking system*. 5th International Power Engineering and Optimization Conference (PEOCO2011). 2011; 107-110.
- [6] L Milea, M Dascalu, O Oltu, A Zafiu. *Two axis detector for photovoltaic panels' automatic full angle orientation,* *Semiconductor Conference (CAS)*. IEEE International Conference Publication. 2010; 125-128.
- [7] Esram T, Kimball JW, Krein PT, Chapman PL, Midya P. Dynamic maximum power point tracking of photovoltaic arrays using ripple correlation control. *IEEE Transactions*. 2006; 21(5): 1282–1291.
- [8] Zhang Bao-jian, Gao Guo-hong, Zhu Yan-li. *Designment of automatic tracking system of solar energy system*. 2<sup>nd</sup> International Conference on Industrial Mechatronics and Automation. 2010; 2: 689–691.
- [9] Jon S Wilson, *Sensor Technology Handbook*, Newnes Publisher. 2004.
- [10] Michael Boxwell, *Solar Electricity Handbook*, Greenstream Publishing. 2012.
- [11] Richard J Komp. *Practical Photovoltaics : Electricity from Solar Cells*. 3<sup>rd</sup> Edition, Aatec Publication. 1995.
- [12] Winson Current Sensor Device, WCS2702, Availabel online 'http://data.icbank.com/ICBShop/board/WCS2702.pdf'.
- [13] HC900 Available online, 'http://www.lesman.com/unleashd/technotes/hc900\_3rdparty\_hmi.pdf'.
- [14] PLCs and SCADA - Rajesh Mehra, Vikrant Vij, Laxmi Publication, 1<sup>st</sup> edition. 2012.
- [15] Introduction to Programmable Logic Controllers - Gary Dunning, Thomson Delmar Learning Second Edition Second reprint 2003.
- [16] Wonderware Intouch, Available online, 'http://global.wonderware.com/EN/Pages/WonderwareInTouchHMI.aspx'.